



User Manual

Hybrid Inverter

EHB Series

5.0-10kW

V1.5-2024-11-26

Contents

01 Safety and Warning	1
1.1 Symbol Conventions	1
1.2 Symbols Explanation.....	3
02 Product Introduction	4
2.1 Operation Modes Introduction	4
2.2 Model	5
2.3 Appearance	5
2.4 LED Indicators Explanation	6
2.5 Product Dimension.....	6
2.6 System Connection Diagrams.....	7
03 Installation Requirements	9
3.1 Environment Requirements.....	9
3.2 Installation Angle and Space Requirements.....	9
3.3 Improper Installation Mode	9
04 Installing the Inverter.....	10
4.1 Packing List	10
4.2 Installing the Inverter	11
05 Electrical Connections.....	12
5.1 Overview of Cable Connections	12
5.2 Connecting the PE cable	13
5.3 Connecting PV Cables	13
5.4 Connecting Battery DC Cables.....	14
5.5 Connecting AC Cables	14
5.6 Connecting Communication Cables and Installing CT	17
5.7 DRED and Remote Shutdown Connection	18
06 Parameter Configuration	19
6.1 Checking Before Turning On AC Power	20
6.2 SolarGo APP Operation	20
6.2.1 Basic Settings.....	20

6.2.2 CEI Auto-Test Function 21

6.2.3 RSD Function 21

6.2.4 Inverter Arc Detection (Optional) 22

6.2.5 Safety Parameter Settings 23

6.3 WiFi Configuration 26

07 Maintenance 27

08 Troubleshootings 28

8.1 Error Message..... 28

8.2 FAQ..... 31

09 Technical Parameters and Certificates 34

10 Appendix 37

1.1 Symbol Conventions

**DANGER!**

DANGER indicates a hazardous situation which, if not avoided, will result in death or serious injury.

**WARNING!**

WARNING indicates a hazardous situation which, if not avoided, could result in death or serious injury.

**CAUTION!**

CAUTION indicates a hazardous situation which, if not avoided, could result in minor or moderate injury.

**NOTE**

NOTE does not indicate any hazardous situation. It supplements description and explanation only.

General safety cautions:

- The documentation may be updated from time to time due to product upgrades or other reasons. Unless otherwise specified, information in the documentation do not replace safety cautions in the labels. All descriptions in the documentation are used for guidance only.
- Please read the user manual carefully to acquire knowledge about product features and safety precautions before installing the equipment. GoodWe will not be liable for any equipment damages or personnel injuries caused by failure to install, operate or configure the inverter in accordance with this document or corresponding user manual.
- Please follow local laws and regulations, and safety cautions in this manual during the installation, operation, and maintenance. Improper operation or misuse may result in personal injuries or property losses.
- All installation, operation, and maintenance must be carried out by trained professionals who meet the following requirements:
 - read through this manual
 - be familiar with various safety precautions
 - operate properly
 - acquaint with local laws, regulations, and standards.
- To ensure safety, please use insulated tools and wear personal protective equipment when operating the equipment.
- Always comply with electrostatic protection rules. To protect the inverter from being damaged, please wear anti-static gloves, wrist strap and clothes when touching printed circuit board or other electrostatic sensitive components during operation.

Operation Safety Precautions:

- The equipment can get hot during operation. Touching the hot surface can result in burn injuries.
- Do not plug or pull DC/AC terminals when the equipment is running.
- PV negative (PV-) and battery negative (BAT-) on inverter side is not grounded by default. Connecting PV- or BAT- to EARTH is strictly forbidden.
- PV modules used on the inverter must have an IEC61730 class A rating, and the total open-circuit voltage of PV string/array is lower than the maximum rated DC input voltage of the inverter. Any damage caused by PV over-voltage is beyond warranty.
- When the inverter leakage current to ground is $\geq 6\text{mA}$, it can be detected by the built-in RCMU function. Type A ($\geq 30\text{mA}$) residual current device is recommended.

- In Australia, the inverter internal switching does not maintain neutral integrity, which must be addressed by external connection arrangements like in the system connection diagram for Australia.
- In Australia, output of Back-Up side in switchbox should be labeled “Main switch UPS supply”, the output of normal load side in switch box should be labeled “main switch inverter supply”.
- Power off the equipment before any cable connection or electrical operation.
- Residual high voltage exists after the equipment is powered off. To avoid electric shock, please wait for 5minutes for the equipment to discharge to safe voltage.
- Destroying the labels without authorization will void the guarantee of corresponding modules.
- If the equipment is not to be installed immediately, put it inside the original package with the desiccant. If the equipment is unpacked but not put into use immediately, seal all unused terminal ports to prevent dust and water vapor corrosion.

Warranty Declaration:

- The equipment damage caused by following reasons are not covered by warranty:
- Exceed the guarantee period.
- Improper installation, alteration, transportation or operation.
- The installation or operation environment is beyond the requirements of this manual or local laws and regulations.
- Force majeure (lightening, earthquake, fire disaster, storm or volcanic eruption etc.)
- Unauthorized replacement, dismantle, maintenance or modification of software code.
- Failure to comply with local laws and regulations, and safety precautions in this manual.
- For more warranty conditions, please visit www.goodwe.com.

1.2 Symbols Explanation

The hybrid or bidirectional solar inverter strictly comply with related safety rules for product design and testing. Please read and follow all the instructions and cautions on the hybrid inverter or user manual during installation, operation or maintenance, as any improper operation might cause personal injury or damage.



Caution!

Failing to observe a warning indicated in this manual may result in injury.



Danger of high voltage and electric shock!



Danger of hot surface!



Components of the product can be recycled.



This side up! The package must always be transported, handled and stored in such a way that the arrows always point upwards.



No more than six (6) identical packages being stacked on each other.



Product should not be disposed as household waste.



The package/product should be handled carefully and never be tipped over or slung.



Refer to the operating instructions



Keep dry! The package/product must be protected from excessive humidity and must be stored under cover.



Inverter will be touchable or operable after minimum 5 minutes of being turned off or totally disconnected, in case of any electrical shock or injury.



CE Mark

2.1 Operation Modes Introduction

The hybrid or bidirectional solar inverter applies to solar system with participation of PV, battery, loads and grid system for energy management. The energy produced by PV system shall be used to optimize self-consumption, excess power charge battery and the rest power could be exported to the grids. Battery shall discharge to support loads when PV power is insufficient to meet self-consumption. If both PV power and battery power is insufficient, the system will take power form grid to support loads.

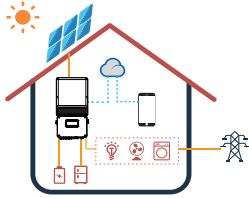

Note: The introduction describes a general behavior of the hybrid or bidirectional solar inverter system. The operation mode can be adjusted on SolarGO APP based on the system layout. Below are the general operation based on the system layout. Below are the general operation modes for the hybrid or bidirectional solar inverter system.

The solar inverter system normally has the following operation modes based on your configuration and layout conditions.

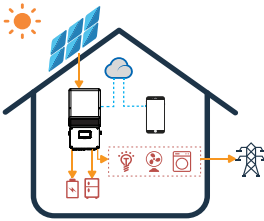

Mode I

The energy produced by the PV system is used to optimize self-consumption. The excess energy is used to charge the batteries, then exported to grid.

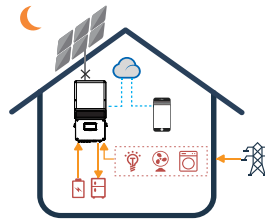

Mode II

When there is no PV, and the battery is sufficient, it can supply the load with the grid together.

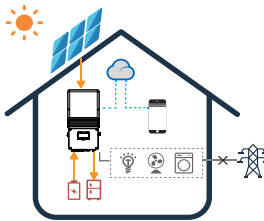

Mode III

When grid fails, the system automatically switches to Back-Up mode, the Back-Up load could be supported by PV and battery.

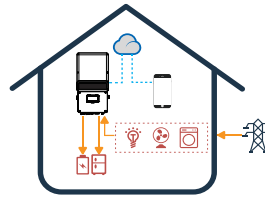

Mode IV

Battery could be charged by grid, and charge time/power could be set flexibly on SolarGo APP.

2.2 Model

EHB series inverter models:





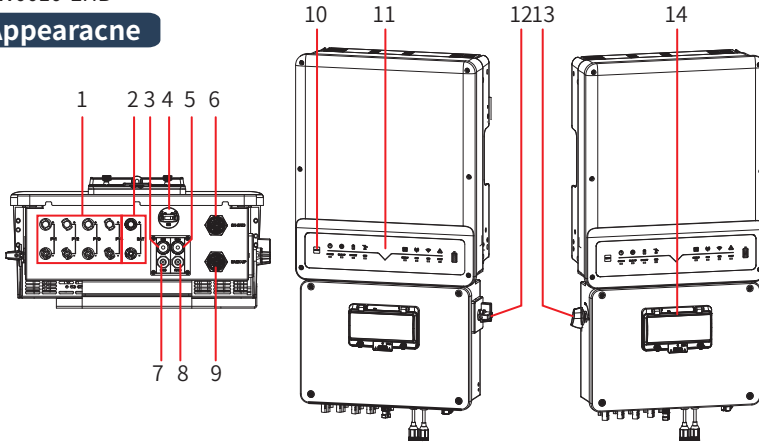







































- GW5000-EHB
- GW6500-EHB
- GW8600-EHB
- GW0010-EHB

2.3 Appearance



No.	Part	Description
1	PV input port	To connect PV strings.
2	Battery input port	To connect the battery.
3	BMS port	To connect the BMS communication part of the battery.
4	WiFi/Bluetooth port	To install the WiFi/Bluetooth communication module.
5	METER port	To connect the meter.
6	ON-GRID port	To connect to the power grid.
7	DRED communication port	To connect to DRED for communication.
8	RS485 port	To connect data monitor devices. When the LG RESH10-TypeR battery is applied, it's used to connect the enable signal port of the battery.
9	BACK-UP port	To connect the BACK-UP load. The BACK-UP port of the inverter is designed with uninterruptible power supply function. The inverter will supply power to the load to keep them working when the power grid is disconnected.
10	WiFi Reset Button	For WiFi Reset and WiFi Reload.
11	Indicator	To indicate the status of the inverter.
12	Bypass switch	Turn the switch to "bypass" when the inverter fails to work. The power grid will supply the BACK-UP load.
13	DC switch	Shutdown the PV system in an emergency. DC switch also works as switch of Rapid Shut Down (RSD).
14	Breaker	<ul style="list-style-type: none"> • Disconnect the inverter from the grid by ON-GRID breaker. • Disconnect the inverter from the BACK-UP load by BACK-UP breaker

2.4 LED Indicators Explanation

INDICATOR	COLOR	STATUS	EXPLANATION
 SYSTEM			ON = System is ready
			BLINK = System is starting up
			OFF = System is not operating
 BACK-UP			ON = Back-up is ready / power available
			OFF = Back-up is off / on power available
 BATTERY			ON = Battery is charging
			BLINK 1 = Battery is discharging
			BLINK 2 = Battery is low / soc is low
			OFF = Battery is disconnected / not active
 GRID			ON = Grid is active and connected
			BLINK = Grid is active but not connected
			OFF = Grid is not active
 ENERGY			ON = Consuming energy from grid / buying
			BLINK 1 = Supplying energy to grid / zeroing
			BLINK 2 = Supplying energy to grid / selling
			OFF = Grid not connected or system not operating
 COM			ON = BMS and meter communication ok
			BLINK 1 = Meter communication ok, BMS communication fail
			BLINK 2 = BMS communication ok, meter communication fail
			OFF = BMS and meter communication fail
 WiFi			ON = WiFi connected / active
			BLINK 1 = WiFi system resetting
			BLINK 2 = WiFi not connect to router
			BLINK 4 = WiFi server problem
			OFF = WiFi not active
 FAULT			ON = Fault has occurred
			BLINK1 = Overload of back-up / Output / reduce load
			BLINK4 = CT wiring fault
			OFF = No fault

2.5 Product Dimension

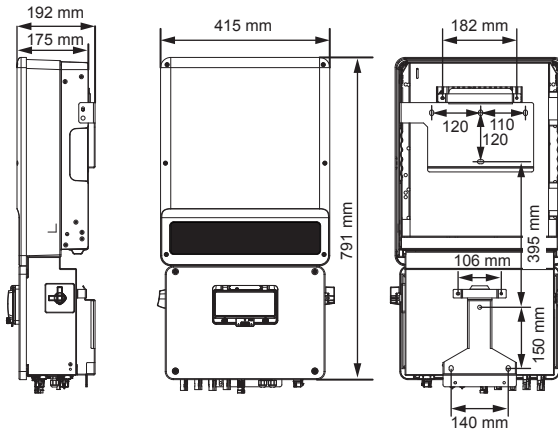

2.6 System Connection Diagrams



WARNING!

- For Australia safety country, the neutral cable of On-Grid side and Back-Up side must be connected together, otherwise Back-Up function will not work.
- When the inverter is working tied to the grid with its backup function enabled, it will automatically switch to the backup mode if the grid suddenly disconnected. Please confirm that the backup mode is normal.

The diagram is an example for application that Neutral connects together with PE in distribution box.

Such as: Australia, New Zealand, etc(Please follow local wiring regulations)

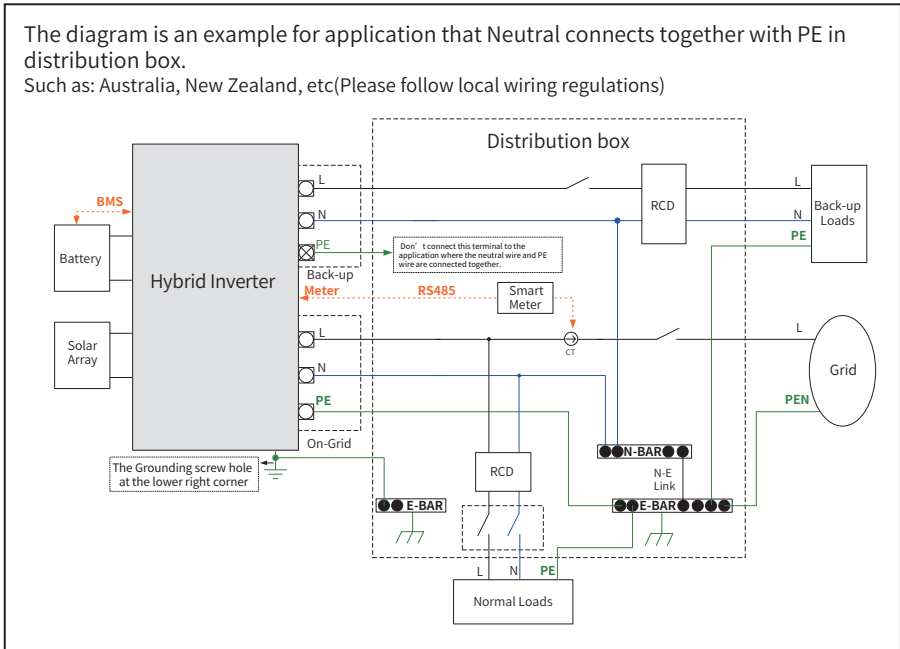

The diagram is an example for application that Neutral separates with PE in distribution box.

Such as: Australia, New Zealand, etc(Please follow local wiring regulations)

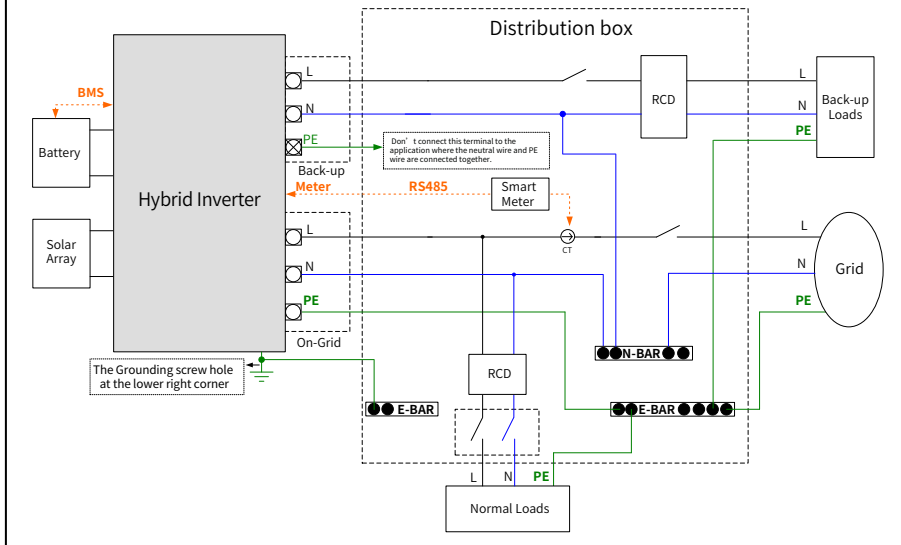

The diagram is an example for application that Neutral separates with PE in distribution box.

Such as: China,Germany, South Africa, Czech Republic, Italy, Brazil, etc. (Please follow local wiring regulations)

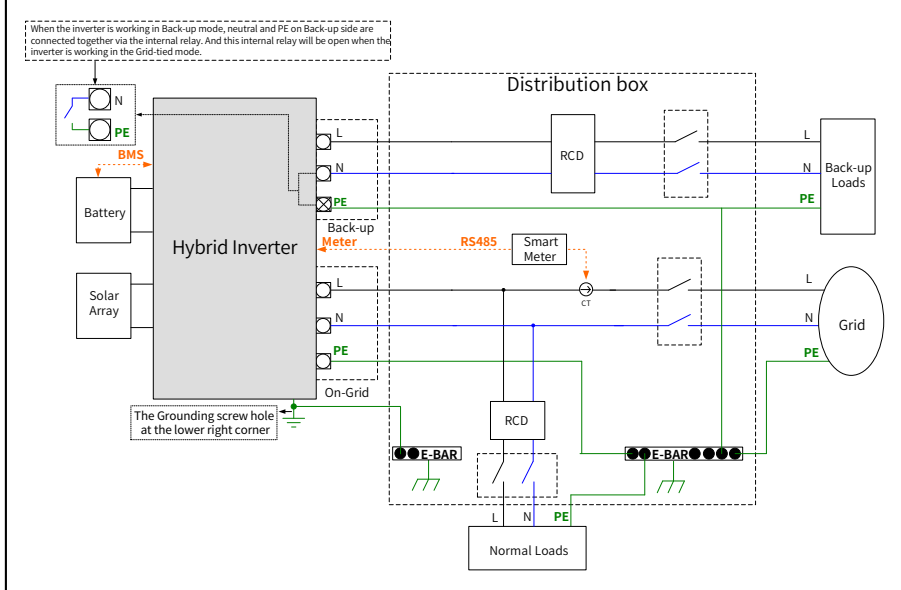

3.1 Environment Requirements

- Any part of this system shouldn't block the switch and breaker from disconnecting the inverter from DC and AC power.
- Inverter should be installed at eye level for convenient maintenance.
- Inverter should be installed on a solid surface, where it is suitable for inverter's dimensions and weight.
- Ambient temperature should be lower than 45°C. (High ambient temperature will cause power derating of inverter.)
- It is recommended that the installation of the inverter should be prevented from direct sunlight, snow, rain and other negative influences which may effect product function or lifetime.
- Product label on inverter should be clearly visible after installation. Do not damage the label.

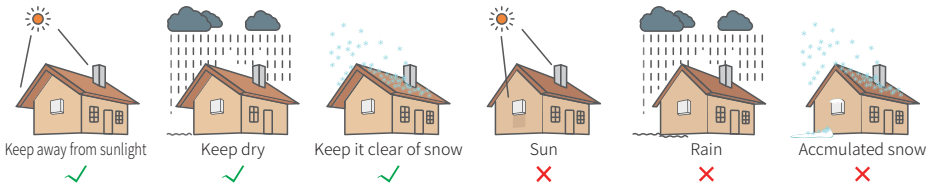

3.2 Installation Angle and Space Requirements

Inverter should be installed vertically or lie on a slope by a max of 15°.

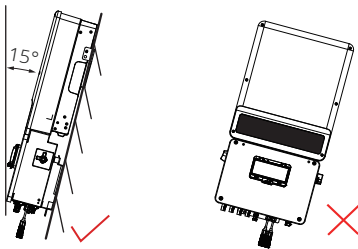

Leave enough space around the inverter according to the below figure for natural heat dissipation.

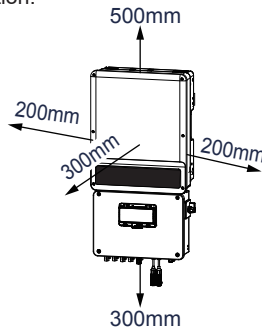

3.3 Improper Installation Mode

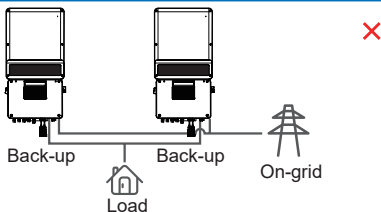

No parallel connection of the back-up is allowed in general application. Please contact the Service Center first for advanced application.

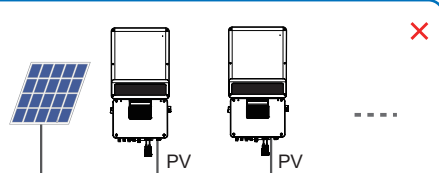



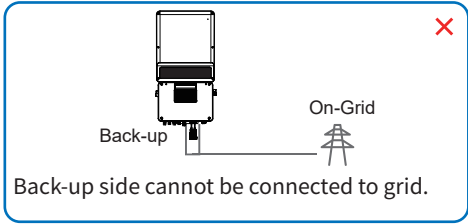
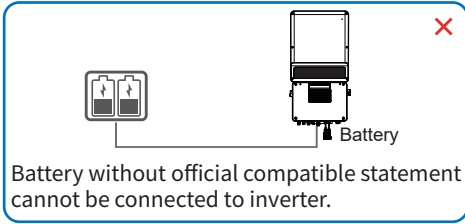
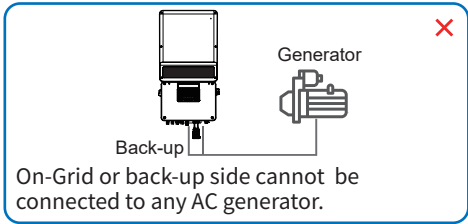
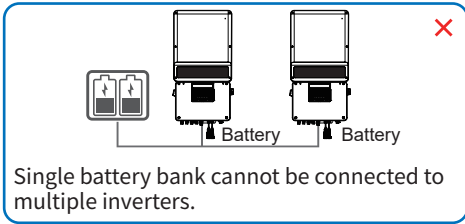





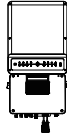
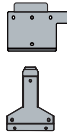

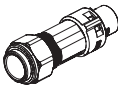
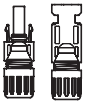

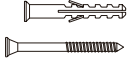
Single PV string cannot be connected to multiple inverters.



04 Installing the Inverter

4.1 Packing List

 Inverter x1	 Wall mounted bracket x1	 Locating plate x1	 AC plug *2	 PV Plug xN*
 Smart meter *1	 Expansion bolts *7	 BAT plug *1	 WiFi module *1	 Screwdriver *1
 6-pin terminal *1	 PE terminal *1	 Fixed screw *4	 Bluetooth module *1	 Documents *1

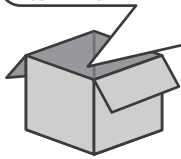

NOTE

[1], [2]: Supplied according to PV port numbers.
 [3]: Including Quick Installation Guide, User Manual, etc.

4.2 Installing the Inverter



CAUTION!

- Do not install the inverter when it is snowing or raining. If you have to, pay attention to the waterproof and moisture-proof of the inverter and distribution box.
- Avoid drilling holes in walls which with cables inside or on the back.

1. Drill holes with the help of installation locating plate.
2. Install the wall-mounted bracket.

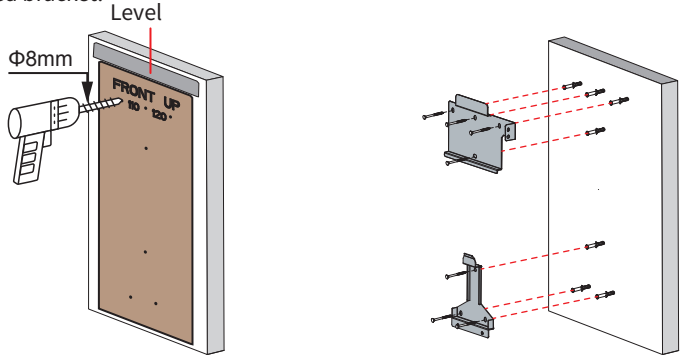

3. Install the inverter.

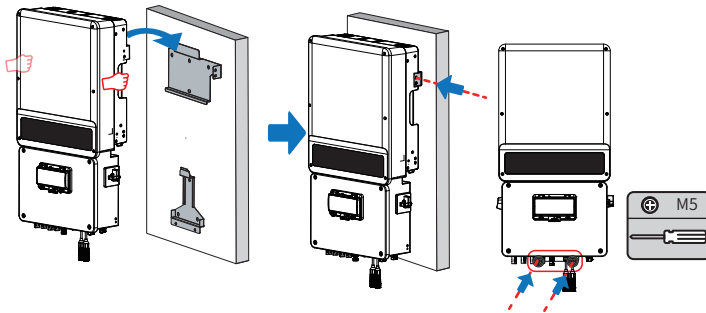

WARNING!

- Do not use force beyond the heatsink sides to avoid damage to the inverter.
- The connection unit cannot lift holding.
- Avoid holding and lifting the connection unit, keep balance of the inverter during moving.

4. Secure the inverter with a lock.
5. Ensure that the switch is on "OFF" position and locked during installation and maintenance. (Applicable in Australia and New Zealand)

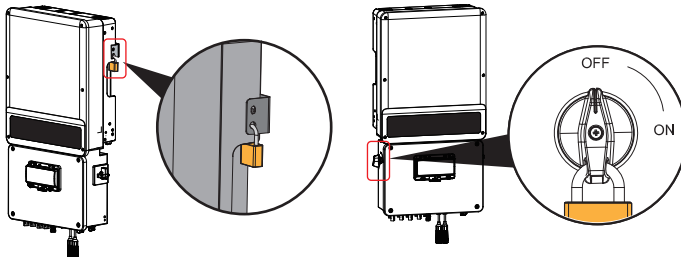



- During wiring connection, the operator should always wear proper PPE.
- The wiring installation must strictly observe correct specification. Otherwise, it may bring waterproof and electrical problems.
- Direction of the CT cannot be connected in reverse, please follow House(K)→Grid (L) direction to do the connection.

5.1 Overview of Cable Connections

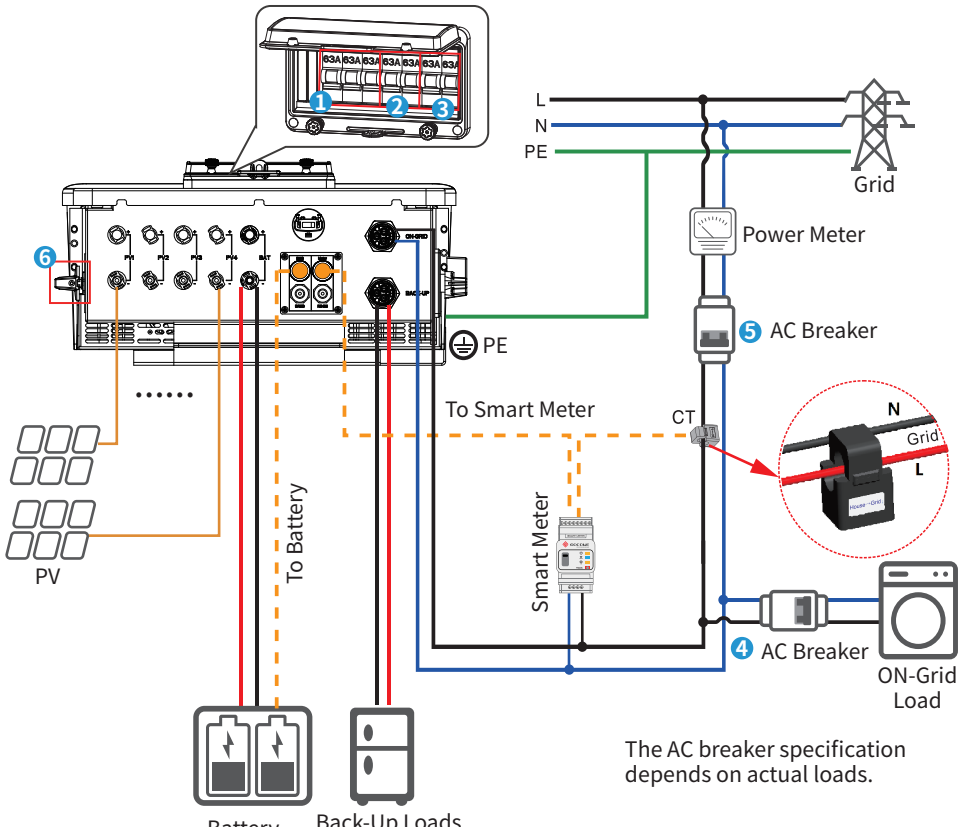

Cable Specifications

Model	PV Cable	BAT Cable	AC Cable	PE Cable
GW5000-EHB	3-4mm ²	12-13mm ²	5-6mm ²	5-6mm ²
GW6500-EHB	3-4mm ²	12-13mm ²	8-10mm ²	8-10mm ²
GW8600-EHB	3-4mm ²	12-13mm ²	10-12mm ²	10-12mm ²
GW0010-EHB	3-4mm ²	12-13mm ²	10-12mm ²	10-12mm ²

5.2 Connecting the PE cable

Ground cable shall be connected to ground plate on grid side.

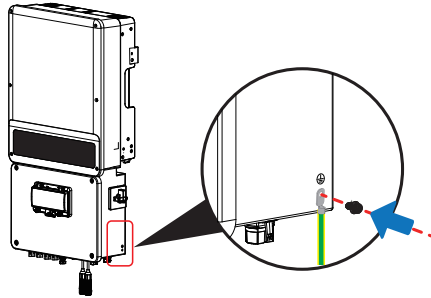

5.3 Connecting PV Cables



CAUTION!

- The total short-circuit current of PV string must not exceed inverter's max DC current.
- The minimum isolation resistance to ground of the PV string must exceed 19.33kΩ in case of any shock hazard.
- The polarity of PV strings or on the inverter cannot be connected by reversely, otherwise inverter could be damaged.
- PV strings could not connect to earth/grounding conductor.
- Use the right PV plugs in the accessory box. (BAT plugs are similar with PV plugs, please confirm before use it.)
- There will be MC4 plugs in accessory box.

1. Prepare PV cables and PV plugs.
2. Connect PV cable to PV connectors.
3. Screw the cap on and plug onto inverter side.

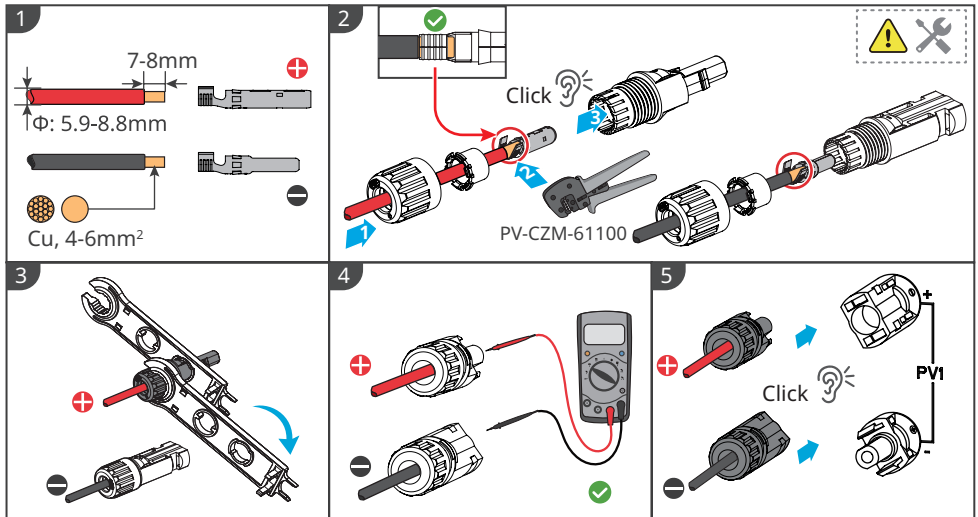

NOTE

- PV cable must be tightly crimped in to the connectors.
- There will be a click sound if connectors are inset correctly into PV plugs.

5.4 Connecting Battery DC Cables



CAUTION!

- Make sure battery breaker is off and battery nominal voltage meet the Hybrid Inverter specification before connecting battery to inverter and make sure inverter is totally isolated from PV and AC power.
- Please be careful against any electric shock or chemical hazard.
- Please following Cments and steps bellow strictly. Use improper wire may cause bad contact and high impedance, which is dangerous to the system.
- Use the right BAT plugs in the accessory box.
- Use the tin-plated cables with a conductor cross section of 10 to 16 mm² because the maximum battery current is 50A.

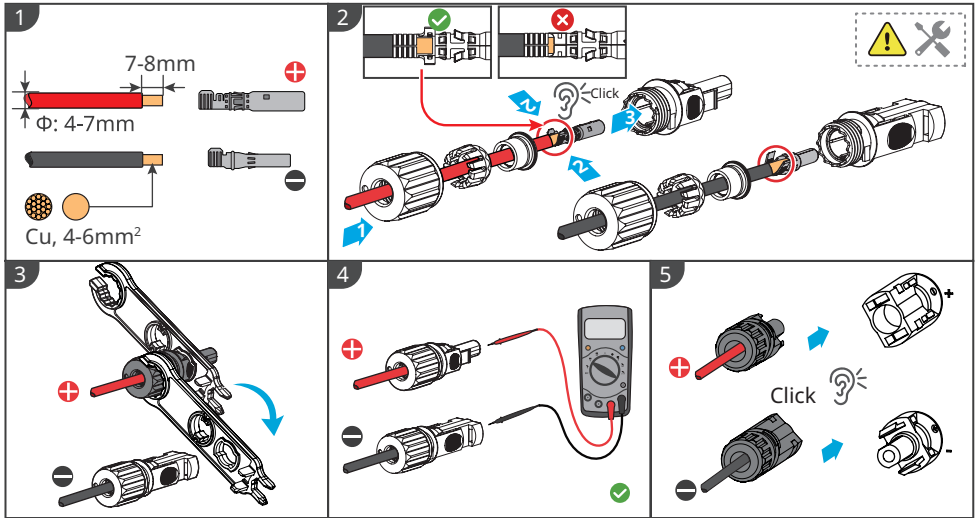

5.5 Connecting AC Cables

- AC circuit breakers shall be installed on the grid side and the load side. Select the AC breaker according to the actual load.
- When there is no need to connect AC cables, the terminal cover should not be removed from the ON-GRID and Back-UP ports to ensure that the ports are protected and there is no risk of electric shock for personnel.

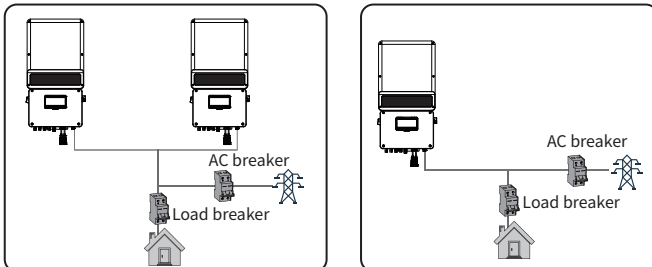

Requirements of AC cable connected to On-Grid and Back-Up side



1. Make sure inverter is totally isolated from any DC or AC power before connecting AC cable.
2. The choice of AC cable needs to meet both the outside diameter and conduct core section requirements. Please refer to the table for selecting the AC cable.
3. Neutral cable shall be blue, line cable is black or brown (preferred) and protective earth cable yellow-green.
4. For AC cables, PE cable shall be longer than N&L cables, so that if in any case AC cable slips or taken out, the protecting earth conductor will be the last to take the strain.

1. Prepare the terminals and AC cables.
2. Put AC cable through terminal cover and screw the three cables tightly on the connectors.
3. Lock terminal cover and screw up the terminal cap.
4. Connect the assembled AC terminals onto inverter.

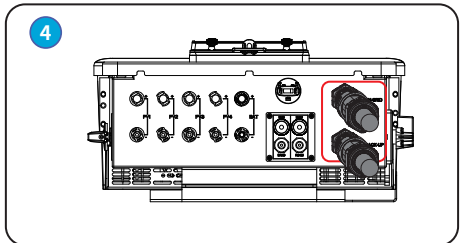
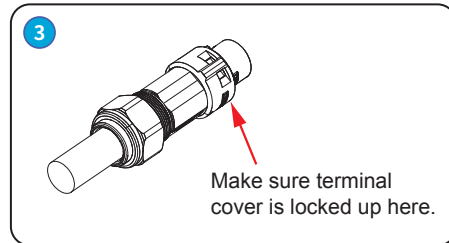
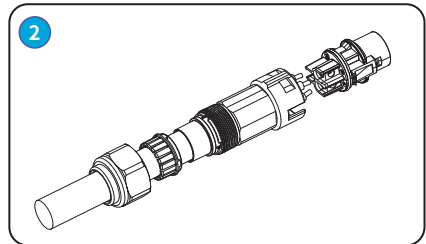
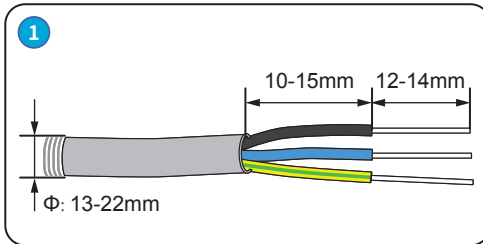

Connection For SPLIT Grid System

In SPLIT grid system, there is a solution allowing inverter to work under On-Grid condition. But the export power and load power might be detected inaccurately as the nominal output power of inverter is 230V and there could be loads of 110V or 220V.

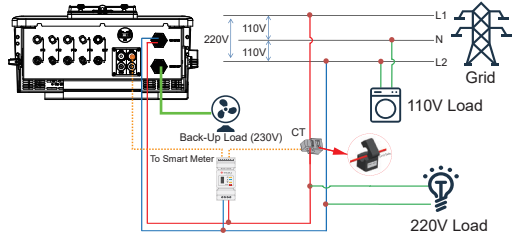

Declaration For Back-Up Function

The below statement lays out the general policies governing the hybrid inverter.

1. For hybrid inverters, the standard PV installation typically consists of the connection of the inverter with both panels and batteries. In case of systems not connected to the batteries, the Back-Up function is strongly not advised to use. GoodWe shall not cover the standard warranty and be liable for any consequences arising from users not following this instruction.
2. Under normal circumstances, the Back-up switching time is less than 10 ms (the minimal condition to be considered as the UPS level). However, some external factors may cause the system to fail on Back-Up mode. As such, we recommend the users to be aware of conditions and follow the instructions as below:
 - 1) Do not connect loads if they are dependent on a stable energy supply for a reliable operation.
 - 2) Do not connect the loads which may in total exceed the maximum Back-Up capacity.
 - 3) Try to avoid those loads which may create very high start-up current surges such as Inverter Air-conditioner, high-power pump etc.
 - 4) Due to the condition of battery itself, battery current might be limited by some factors including but not limited to the temperature, weather etc.

Declaration For Back-Up Loads

The hybrid inverters are able to supply over load output at its' Back-Up. For details please refer to the technical parameters of the hybrid inverter. And the inverter has self-protection derating at high ambient temperature.

Accepted loads as below:

Inductive Load: For GW5000-EHB and GW6500-EHB, a 1.5P non-frequency conversion air-conditioner can be connect to back-up side. For GW8600-EHB and GW0010-EHB, a 2P non-frequency conversion air-conditioner can be connect to back-up side. The uninterrupted power supply of the inverter will become unstable if the air conditioner is connected beyond required.

Capacitive Load: Total power $\leq 0.6 \times$ nominal power of model. (Any load with high inrush current at start-up is not accepted.)

For complicated application, please contact the Service Center.

Declaration For Back-Up Overload Protection

Inverter will restart itself as overload protection happens. The preparation time for restarting will be longer and longer (max one hour) if overload protection repeats. Take following steps to restart inverter immediately.

- Decrease Back-Up load power within max limitation.
- On SolarGo → Advanced Setting → Click “Reset Back-Up Overload History”

5.6 Connecting Communication Cables and Installing CT

- The Smart Meter with CT in product box is compulsory for the hybrid inverter system installation, used to detect grid voltage and current direction and magnitude, further to instruct the operation condition of the hybrid inverter via RS485 communication.
- Choose standard network cables and RJ45 terminals only for communication.



1. Make sure AC cable is totally isolated from AC power before connecting Smart Meter & CT.
2. The Smart Meter and CT is well configured, please do not change any setting on Smart Meter.
3. One Smart Meter can only be used for one hybrid inverter.
4. CT must be connected on the same direction as the CT indicated.

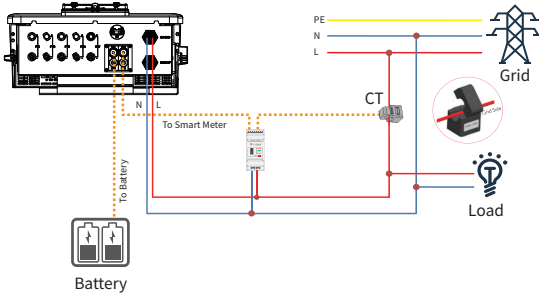

- CT cable is 3m as default, could be extended to max 5m.
- Choose standard network cables and RJ45 terminals only for communication.
- Communication cables of Smart Meter can expand to 100m to ensure normal communication. Normally, BMS communication cables are 3~5M.

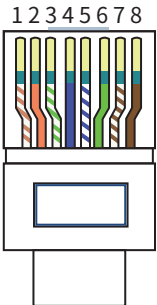

NO.	Color	BMS Function	Smart Meter Function
1	Orange&White	485_A2	N/A
2	Orange	N/A	N/A
3	Green&White	485_B2	485_B1
4	Blue	CAN_H	N/A
5	Blue&White	CAN_L	N/A
6	Green	N/A	485_A1
7	Brown&White	N/A	485_B1
8	Brown	N/A	485_A1

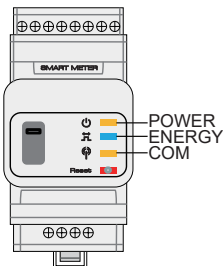

Smart Meter LED Indications

	OFF	ON	Blinking
POWER	Not working	Working	N/A
ENERGY	N/A	Importing	Exporting
COM	Blink one time when it transfer data to inverter.		

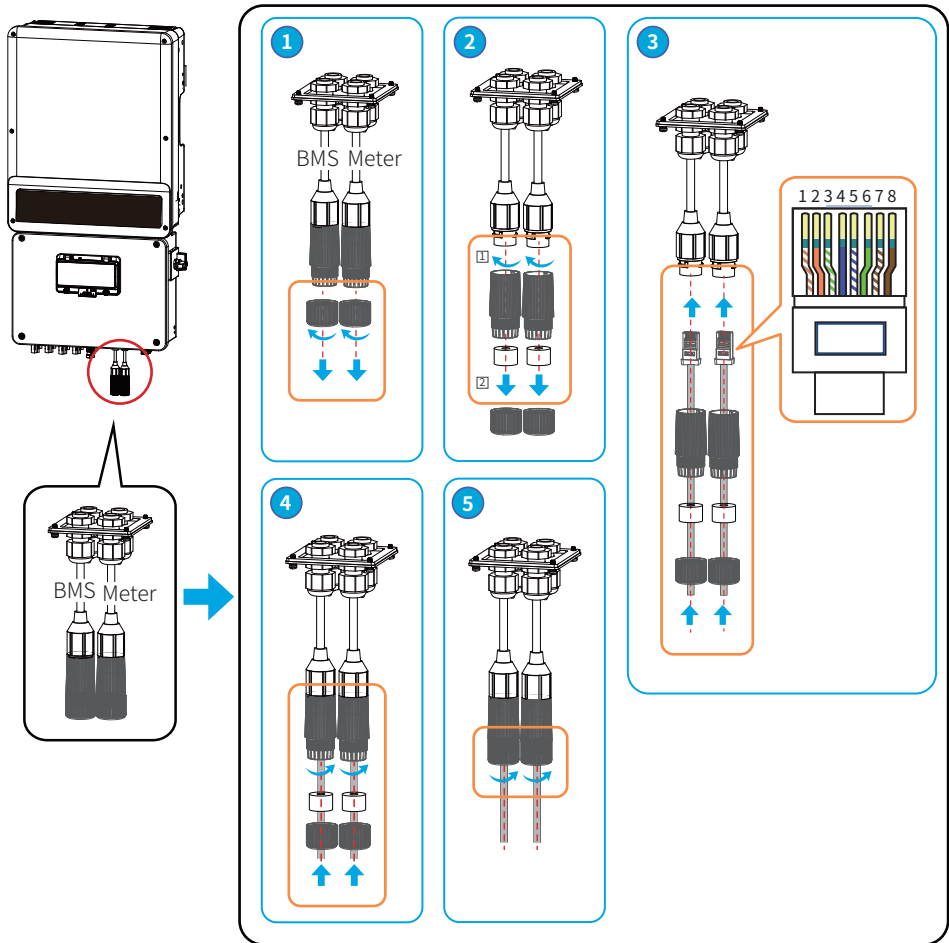

5.7 DRED and Remote Shutdown Connection

DRED is used for Australia and New Zealand installation (also used as remote shutdown function in European countries), in compliance with Australia and New Zealand safety requirements (or European countries). And DRED device is prepared by the customer.

NO.	DRED port definition	Reserved port definition	RS485 port definition
1	DRM1/5	CANL2	RS485_B2 ^[2]
2	DRM2/6	CANH2	RS485_A2 ^[2]
3	DRM3/7	GND-S	LG_EN- ^[3]
4	DRM4/8	12V-S	LG_EN+ ^[3]
5	REFGEN/Remote Shutdown ^[1]	NODE-	RS485_B1 ^[4]
6	COM/DRM0/Remote Shutdown ^[1]	NODE+	RS485_A1 ^[4]



CAUTION!

- [1]: Please connect to 5/6PIN of DRED port if Remote Shutdown is applied.
- [2]: Connect BMS to this port if a battery with RS485 port is selected.
- [3]: For LG RESH10-TypeR battery, connect the BMS cable to RS485_A2/B2 port and connect the enable cable to LG_EN+ and LG_EN-.
- [4]: Used to connect the data monitoring device.
- The RS485 port shall be connected in the same way as the DRED port.
- If the DRED and Remote Shutdown functions are not used, make sure that the Resistance is inserted into the DRED Terminal.

1 DRED Cable connection

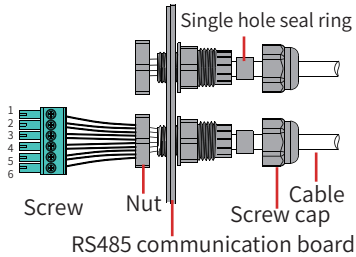

2 Remote Shutdown Cable connection

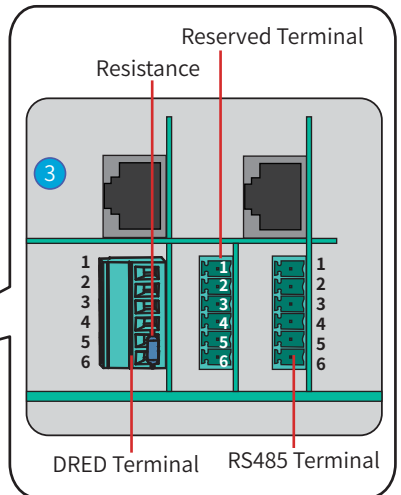
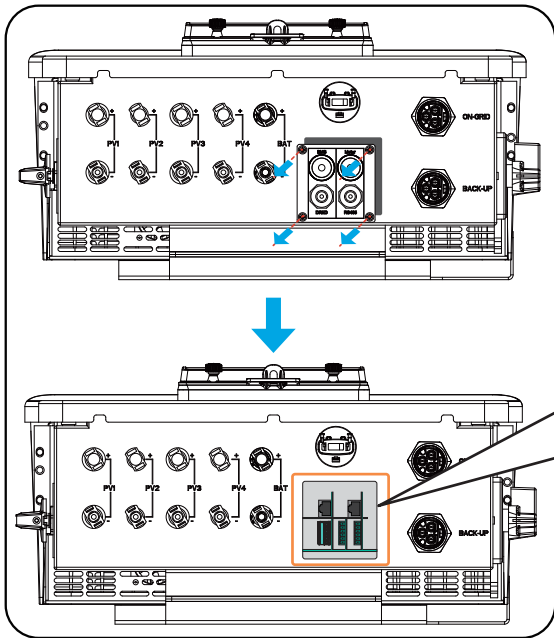
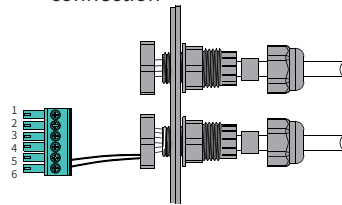

06

Parameter Configuration

6.1 Checking Before Turning On AC Power

1. Battery Connection: Confirm the connection between inverter and battery, polarity (+/-) are not reversed.
2. PV Input Connection: Confirm the connection between inverter and battery, polarity (+/-) are not reversed.
3. On-Grid & Back-Up Connection: Confirm ON-GRID connection to power grid and Back-Up to loads, polarity (L/N are in sequence) not reversed.
4. Smart Meter & CT Connection: Make sure Meter & CT are connected house loads and grid, and follow the Smart Meter direction sign on CT.

6.2 SolarGo APP Operation

6.2.1 Basic Settings

- SolarGo app is an external monitoring/configuration application for the hybrid inverters.
- Please download SolarGo app from GoodWe official website (www.goodwe.com).
- Connect to the WiFi/Bluetooth port to access the WiFi module/Bluetooth module, and realize the communication between the inverter and APP.



SolarGo App

1 Connect Device

2 Inverter with Wi-Fi

3 Searching devices, please wait...

4 Login

5 Settings

6 Basic Setting

7 Next

- Bluetooth name: SOL-BLE*****
- WiFi name: Solar-WiFi*****
- WiFi password: 12345678
- " * " Represents the last 8 digits of the serial number of the inverter.

Select the battery type.

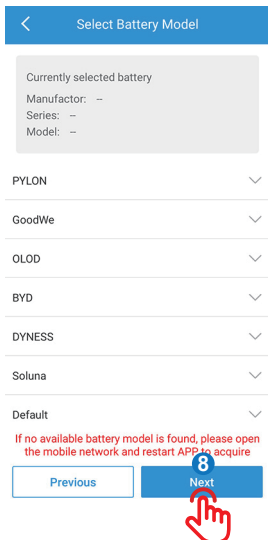

Check the meter direction.

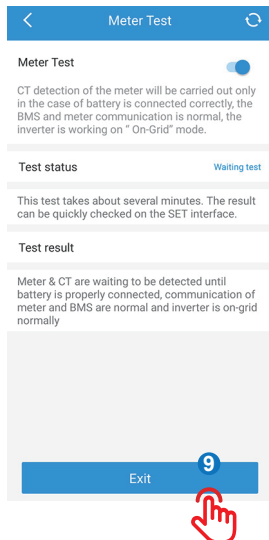

Check the inverter and battery status.

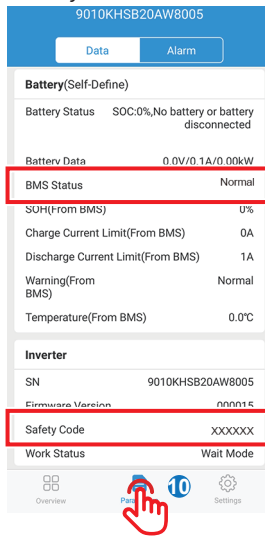

WiFi Reset & Reload

WiFi Reset & Reload function is only used when:

1. WiFi lost connection to internet or cannot connect to SolarGo APP successfully.
 2. Cannot find “Solar-WiFi signal” or have other WiFi configuration problem.
 3. Please do not use this button if WiFi monitoring works well.
- WiFi Reset means restarting WiFi module, WiFi settings will be reprocessed and saved automatically. Short press REST button, WiFi LED on inverter will blink for a few seconds.
 - WiFi Reload means setting WiFi module back to default factory setting. Long press REST button (longer than 3s), WiFi LED on inverter will blink until doing WiFi configuration again.

6.2.2 CEI Auto-Test Function

PV Auto-Test function of CEI is integrated in SolarGo APP for Italy safety country requirement. For detailed instruction of this function please refer to SolarGo Operation Instructions.

6.2.3 RSD Function

The inverter supports the RSD function, which is optional and requires a quick shutdown device. Once the DC switch is turned off, the PV module can be quickly turned off.

6.2.4 Inverter Arc Detection (Optional)

An electric arc is a gas discharge phenomenon. An instantaneous spark caused by an electric current passing through some insulating medium (such as air).

The cause of the electric arc:

- Connector is not connected well in photovoltaic system
- Incorrect or broken cable connection
- Deterioration of connectors and cables due to aging of photovoltaic systems

Arcs generate heat which can cause fires and they also pose an electrocution risk to those working near them.

Use of the arc detection function

The Arc detection function is integrated in the hybrid inverter. Once an arc is detected, the corresponding error and time will be reported in the App. The first 4 faults of the inverter within 24 hours can be resolved by automatic recovery or manual recovery. After the 5th arc fault the inverter must be stopped. Only after the site troubleshooting or the problem components are replaced, and the fault error is manually cleared, can the machine work normally. AFCI function needs to be operated in SolarGo App:

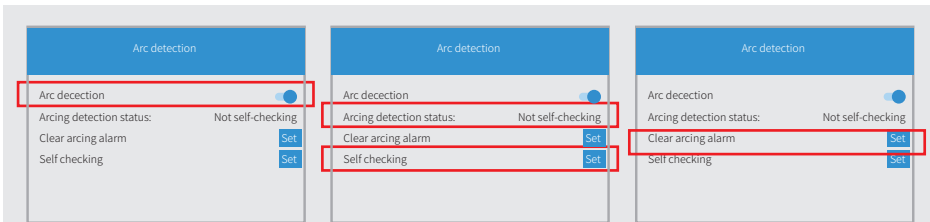

Turn on Arc detection function: "Settings→ Advanced Setting→ Arc detection→ Arc detection".

Self checking function: "Settings→ Advanced Setting→ Arc detection→ Self checking". After the self-test is completed, the test result will be displayed in the "Arcing self-test status".

Clear arcing alarm function: "Settings→ Advanced Setting→ Arc detection→ Clear arcing alarm"



NOTE

Since the arc detection function is optional, SolarGo will remind you it's Unactivated if the function is not activated in the inverter you purchased. Please contact service center to activate the arc detection function if you need.

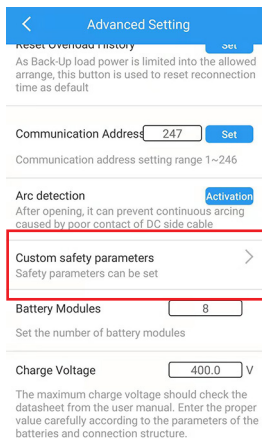

Advanced Setting

Reset Overload history

As Back-Up load power is limited into the allowed arrange, this button is used to reset reconnection time as default

Communication Address

Communication address setting range 1~246

Arc detection

After opening, it can prevent continuous arcing caused by poor contact of DC side cable

Custom safety parameters

Safety parameters can be set

Battery Modules

Set the number of battery modules

Charge Voltage V

The maximum charge voltage should check the datasheet from the user manual. Enter the proper value carefully according to the parameters of the batteries and connection structure.

6.2.5 Safety Parameter Settings

Set the QU curve, PU curve, and PF power curve in SolarGo. Please contact the service center if you need to set them. (For Australia and New Zealand only)

Steps to set the curves: "**Settings**→**Advanced Setting**→**Custom safety parameters**→**Curve setting**"

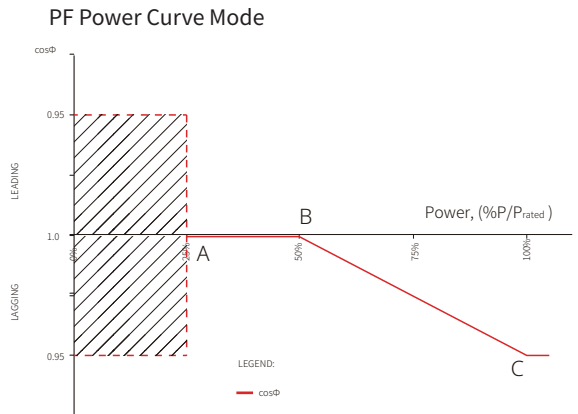

PF Power Curve Mode			
Function	Default value (Australia)	Default value (New Zealand)	Setting range
B %P/Prated	50%	50%	30%~80%
C Power factor	0.9	0.9	0.8-1

Power Recovery Slope

Power Recovery Slope		
Function	The default value (Australia & New Zealand)	Setting range
Rising slope	16.67%Pn/min	5-100%Pn/min
Falling slope	16.67%Pn/min	5-100%Pn/min

PU curve Mode

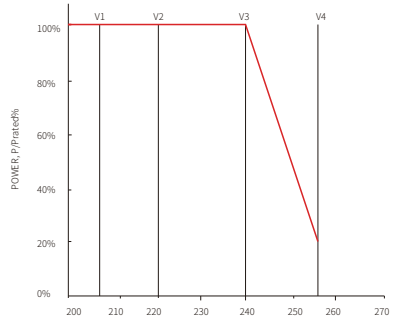
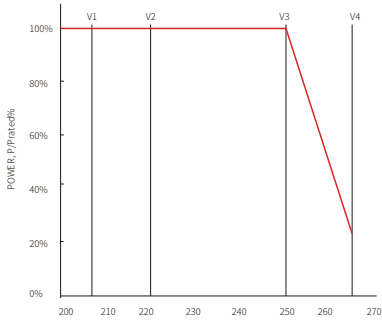

PU curve Mode (Discharge)

Function	Default value (Australia)	Default value (New Zealand)	Setting range
V1 voltage ratio	207V	207V	Not applicable
P1 power ratio	100%*Pn	100%*Pn	0-100%*Pn
V2 voltage ratio	220V	220V	216 to 230
P2 power ratio	100%*Pn	100%*Pn	0-100%*Pn
V3 voltage ratio	250V	244V	235 to 255
P3 power ratio	100%*Pn	100%*Pn	0-100%*Pn
V4 voltage ratio	265V	255V	244 to 265
P4 power ratio	20%*Pn	20%*Pn	0-20%*Pn

PU curve Mode (Charge)

Function	Default value (Australia)	Default value (New Zealand)	Setting range
V1 voltage ratio	207V	207V	Not applicable
P1 power ratio	0%*Pn	0%*Pn	Not applicable
V2 voltage ratio	220V	220V	216 to 230V
P2 power ratio	100%*Pn	100%*Pn	0-100%*Pn
V3 voltage ratio	250V	244V	235 to 255
P3 power ratio	100%*Pn	100%*Pn	0-100%*Pn
V4 voltage ratio	265V	255V	244 to 265
P4 power ratio	100%*Pn	100%*Pn	0-100%*Pn

QU curve Mode

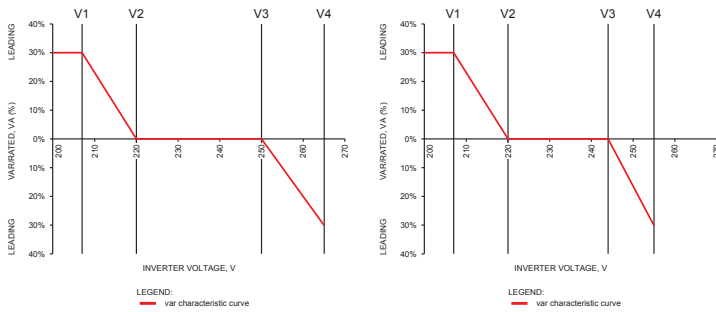

QU curve Mode			
Function	Default value (Australia)	Default value (New Zealand)	Setting range
V1 voltage ratio	207V	207V	Not applicable
Q1 reactive power ratio	30% leading	30% leading	0 to 60% leading
V2 voltage ratio	220V	220V	216 to 230
Q2 reactive power ratio	0%	0%	0%
V3 voltage ratio	250V	244V	235 to 255
Q3 reactive power ratio	0%	0%	0%
V4 voltage ratio	265V	255V	244 to 265
Q4 reactive power ratio	30% lagging	30% lagging	0 to 60% lagging

6.3 WiFi Configuration

- This part shows configuration on web page
- WiFi configuration is absolutely necessary for online monitoring and after-sales maintenance

PREPARATION:

1. The inverter is started.
2. Need a router with available internet access to GoodWe portal: <https://www.semsportal.com>

Step 1

1. Connect Solar-WiFi* to your PC or smart phone (* means the last 8 characters of the inverter serial No.)
2. Open browser and login 10.10.100.253; Admin (U): admin; Password: admin
3. Then click "OK"

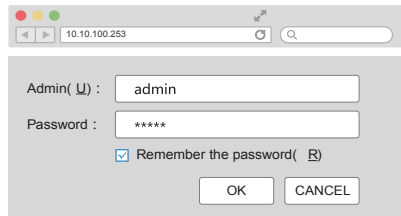

Step 2

Click "Start Setup" to choose your router, then click "Next".

Device information	
Firmware version	1.6.9.3.38.2.1.38
MAC address	60:C5:A8:60:33:E1
Wireless AP mode	Enable
SSID	Solar-WiFi
IP address	10.10.100.253
Wireless STA mode	Disable
Router SSID	WiFi_Burn-in
Encryption method	WAP/WAP2-PSK
Encryption algorithm	AES
Router Password	WiFi_Burn-in

Cannot join the network, may be caused by:

router doesn't exist, or signal is too weak, or password is incorrect

★ Help: Wizard will help you to complete setting within one minute.

Start Setup

Please select your current wireless network:

SSID	Sec mode	Enc type	Channel	RSSI
WIFI Test	WAP2-PSK	AES	6	54%

★ Note: When RSSI of the selected WiFi Network is lower than 10%, the connection may be unstable, please select other available network or shorten the distance between the device and the router.

If your wireless router does not broadcast SSID, please click "Next" and add a wireless network manually.

Back

Next

Step 3

1. Fill in the password of the router, then click "Next".
2. Click "Complete"

Add wireless network manually

Network name (SSID)	WIFI-Test
Encryption method	WPA/WPA2-PSK
Encryption algorithm	AES

Please enter the wireless network password:

Password (8-63 bytes)	hellgoodwe
	show psk

Note: case sensitive for SSID and password

Please make sure all parameters of wireless network are matched with router, including password

Back

Next

Save success!

Click 'Complete', the current configuration will take effect after restart.

If you still need to configure the other pages of information, please go to complete your required configuration.

Configuration is completed, you can log on the Management page to restart device by Click on 'OK' button.

Confirm to complete?

Back

Complete



NOTE

1. Please make sure the password, Encryption Method/Algorithm is right the same with the router's.
2. If everything is right well, the WiFi LED on the inverter will change from double blink to quartic blink then to solid status, which means WiFi is connected to GoodWe icloud successfully.
3. WiFi configuration could also be done on SolarGo, details please check on SolarGo app.

The inverter requires periodically maintenance, details as below:

- Make sure inverter is totally isolated from all DC and AC power for at least 5 mins before maintenance.
- Heat sink: Please use clean towel to clean up heat sink once a year.
- Torque: Please use torque wrench to tighten AC and DC wiring connection once a year.
- DC breaker: Check DC breaker regularly, active the DC breaker 10 times in a row once a year.
- Operating DC breaker will clean contacts and extend lifespan of DC breaker.
- Water-proof covers: Check if water-proof covers of RS485 and other part are fastened once a year.

The fans should be cleared yearly. Before clearing or replacing the fans, turn off all switches including battery switch and AC breaker switch.

Step 1

Rotate DC switch in “OFF” position.

Remove 4 screws by cross screwdriver.

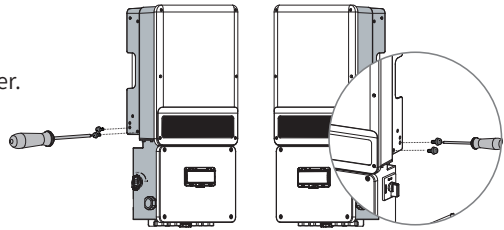

Step 2

Separate the plug terminal by pressing the buckle.



Step 3

Clean the ventilation grid and the fan with soft brush, paint brush, or compressed air.

Reassemble the fans into the cabinet.

If there is something wrong with the fan and need to be repaired or replaced, disassemble the fans following the above steps.

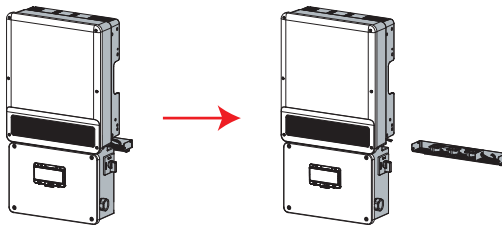

8.1 Error Message

The error message below will be displayed on SolarGo APP or reported by Email if the error really happens.

Error Message	Explanation	Reason	Solutions
Utility Loss	Public grid power is not available (power lost or on-grid connection fails)	Inverter does not detect the connection of grid	<ol style="list-style-type: none"> 1. Check (use multi-meter) if AC side has voltage . Make sure grid power is available. 2. Make sure AC cables are connected tightly and well. 3. If all is well, please try to turn off AC breaker and turn on again in 5 mins.
VAC Failure	Grid voltage is not within permissible range	Inverter detects that AC voltage is beyond the normal range required by the safety country	<ol style="list-style-type: none"> 1. Make sure safety country of the inverter is set right. 2. Check (use multi-meter) if the AC voltage (Between L & N) is within a normal range (also on AC breaker side) <ol style="list-style-type: none"> a. If the AC voltage is high, then make sure the AC cable complies with that required on user manual and the AC cable is not too long. b. If the voltage is low, make sure the AC cable is connected well and the jacket of the AC cable is not compressed into the AC terminal. 3. Make sure the grid voltage of your area is stable and within normal range.
FAC Failure	Grid frequency is not within permissible range	Inverter detects that the grid frequency is beyond the normal range required by the safety country	<ol style="list-style-type: none"> 1. Make sure the safety country of the inverter is set right. 2. If safety country is right, then please check on the inverter display if AC frequency (Fac) is within a normal range. 3. If FAC failure only appears a few times and is resolved soon, it should be caused by occasional grid frequency instability.
PV Over Voltage	PV voltage is too high	The total voltage (open-circuit voltage) of each PV string is higher than the max DC input voltage of the inverter.	Check if PV string Voc is lower than Max PV input voltage of the inverter.If Voc of PV string is high, please decrease panels to make sure Voc is within the max DC input voltage of the inverter.
Over Temperature	Temperature inside of the inverter is too high	The inverter's working environment leads to a high temperature condition	<ol style="list-style-type: none"> 1. Try to decrease surrounding temperature. 2. Make sure the installation complies with the instruction on inverter user manual. 3. Try to close the inverter for 15 mins, then start up again.

Error Message	Explanation	Reason	Solutions
EEPROM R/W Failure	N/A	Caused by a strong external magnetic field etc.	Try to restart the inverter,check if it still occurs.If not,it is just an occasional situation. Otherwise, contact after-sales immediately.
SPI Failure	Internal communication failure	Caused by a strong external magnetic field etc.	Try to restart the inverter,check if it still occurs.If not,it is just an occasional situation. Otherwise, contact after-sales immediately.
DC Bus High	BUS voltage is over-high	N/A	Try to restart the inverter,check if it still occurs.If not,it is just an occasional situation. Otherwise, contact after-sales immediately.
Back-Up Over Load	Back-up side is over loaded	Total back-up load power is higher than the back-up nominal output power	Decrease back-up loads to make sure the total load power is lower than back-up nominal output power (please refer to page 24).
AC HCT Check Failure	The inverter's AC HCT check failure.	Inverter hardware current sensor failure.	Try to restart the inverter, check if it still occurs. If not, it is an occasional situation. Otherwise , contact after-sales immediately.
AFCI Fault	AFCI module detected a failure.	AFCI self-test is abnormal or an arc occurs on the PV terminal of the inverter.	<ol style="list-style-type: none"> 1. If it is the first time this problem has occurred, clear arc fault by App and restart the inverter. If not, it means it is caused by an occasional situation. 2. If the problem persists, check whether connectors or cables in a PV system are improperly connected or are damaged. Unplug all the wires and reconnect or replace the damage cable, Then restart the inverter. If the fault still occurs, contact after-sales.
GFCI Device Check Failure	GFCI Device Check Failure	GFCI device failure	Try to restart the inverter. Check if the fault still occurs. If not, it means it is caused by an occasional situation, or contact after-sales.

Error Message	Explanation	Reason	Solutions
Isolation Failure	Ground insulation impedance of PV string is too low	Isolation failure could be caused by multiple reasons like that the PV panels are not grounded well, DC cable is broken, PV panels are aged or surrounding humidity is comparatively heavy, etc.	<ol style="list-style-type: none"> 1. Use multi-meter to check if the resistance between earth & inverter frame is close to zero. If it's not, please ensure that the connection is well. 2. If the humidity is too high, isolation failure may occur. 3. Check the resistance between PV1+/PV2+/PV3+/PV4+/BAT+/PV- to earth. If the resistance is lower than the minimum isolation resistance shown in the table(chapter 2.4.2) , check the system wiring connection. 4. Try to restart the inverter. Check if the fault still occurs. If not, it means it is caused by an occasional situation, or contact after-sales.
Ground I Failure	Ground leakage current is too high	Ground failure could be caused by multiple reasons like that the neutral cable on the AC side is not connected well or the surrounding humidity is comparatively heavy, etc.	Check (use multi-meter) if there is voltage (normally should be close to 0V) between earth & inverter frame. If there is a voltage, it means the neutral & ground cables are not connected well on the AC side. If it happens only in the early morning/dawn /rainy days with higher air humidity and is recovered soon, it should be normal.
Relay Check Failure	Self checking of relay failure	Neutral & ground cables are not connected well on AC side or just an occasional failure	Check (use multi-meter) if there is high voltage (normally should be lower than 10V) between N & PE cable on the AC side. If the voltage is higher than 10V, it means the Neutral & ground cable are not connected well on AC side or restart inverter.
DC Injection High	N/A	The inverter detects a higher DC component in AC output	Try to restart the inverter, check if it still occurs. If not, it is just an occasional situation. Otherwise, contact after-sales immediately.

8.2 FAQ

NO.	Problems	Solutions
1	The inverter does not start up with battery only.	Make sure the voltage of battery is higher than 100V, otherwise battery cannot start inverter up.
2	The inverter not started up with PV only.	<ol style="list-style-type: none"> 1. Make sure the voltage of PV is higher than 100V (need 200V to enter on-grid mode). 2. Make sure the connection between Inverter and PV panels: polarities are (+/-) not reversed.
3	The inverter doesn't discharge or output without PV or when PV is lower than load power.	<ol style="list-style-type: none"> 1. To check whether the CT is installed correctly, Meter test can be performed in SolarGo. 2. Make sure load power is higher than 100W. <ul style="list-style-type: none"> • Battery will not discharge continuously unless load power is higher than 100W. • If battery does not discharge when Meter power is higher than 100W, please check CT connection and direction. 3. Make sure SOC (State of charge) is higher than 1-DOD (Depth of discharge). Or if battery discharges to below 1-DOD, battery will only discharge again when SOC charged to $(20\%+1-DOD)/2$ (if the battery discharge is needed immediately, the user should restart battery). 4. Check on App whether the charge time has already been set, as during charge time, battery will not discharge (battery will charge in priority during coincident time of charge/discharge).
4	Battery does not charge when PV power higher than load power.	<ol style="list-style-type: none"> 1. Check the discharge time setting on App. 2. Check if battery is fully charged or not, or if battery voltage reaches "charge voltage" or not.
5	High power fluctuation on battery charge or discharge.	<ol style="list-style-type: none"> 1. Check if there is a fluctuation on load power. 2. Check if there is a fluctuation on PV power.
6	Battery does not charge.	<ol style="list-style-type: none"> 1. Make sure BMS communication is OK on SolarGo App. 2. Check if CT is connected in the right position and connected to right direction .
7	Why cannot search Solar-WiFi signal on smart phone?	Normally Solar-WiFi signal could be searched right after inverter powered up. But Solar-WiFi signal will disappear when the inverter connected to internet. If need to change settings, can connect to the router to change. If cannot see WiFi signal even not connect to router, then please try to reload WiFi.
8	Why cannot connect Solar-WiFi signal on my phone?	It is the character of the WiFi module that it can connect to only one device at a time. If the signal is connected to another device at the time for some reason, then you cannot connect to the signal.
9	Why battery does not discharge when grid is not available, while it discharges normally when grid is available?	On APP, Off-Grid output and Back-Up function should be turned on to make battery discharge under Off-Grid mode.

NO.	Problems	Solutions
10	Why there is no output on Back-Up side?	For Back-Up supply, the “Back-Up Supply” on SolarGo App must be turned on. Under Off-Grid mode or grid power is disconnected, “Off-Grid Output Switch” function must be turned on as well. Note: As turn “Off-Grid Output Switch” on, don’t restart inverter or battery, otherwise the function will switch off automatically.
11	On Portal, why battery SOC has a sudden jump up to 95%?	This normally happens on when BMS communication fail on lithium. If battery enter float charge, SOC will be reset to 95% compulsively.
12	Why battery cannot be fully charged to 100%?	Battery will stop charge when battery voltage reaches charge voltage set on SolarGo APP.
13	Why battery switch always trip when starts it up (Lithium battery)?	The switch of lithium battery normally trips for following reasons: 1. BMS communication fails. 2. Battery SOC is too low, battery trips to protect itself. 3. An electrical short-cut happened on battery connection side. Or other reasons please contact the Service Center for details.
14	Which battery should I use for the hybrid inverter?	For the inverter, it could connect lithium batteries which have compatibility with the inverter with nominal voltage from 80V to 495V. Compatible lithium batteries can see on battery list in SolarGo APP.
15	Why Cannot save settings on SolarGo App.	This could be caused by losing connection to Solar-WiFi . 1.Make sure you connected Solar-WiFi (make sure no other devices connected) or router (if connected Solar-WiFi* to router) and on APP home page shows connection well. 2.Make sure restart inverter 10mins later after you do some settings because inverter will save settings every 10 mins under normal mode. We recommend you change setting parameters when inverter under waiting mode.
16	On the App, why the data on the homepage and Param page is different, like charge/discharge, PV value, load value or grid value?	As the data on APP is from inverter and on home page and Param page, the data refresh frequency is different, so there will be a data inconformity between different pages on APP as well as between that on portal and APP.
17	On App, some columns show NA, like battery SOH, etc. why is that?	NA means App does not receive data from inverter or server, normally it is because communication problem, such as battery communication, and communication between inverter and the APP.
18	How to Act Output Power Limit function?	For the hybrid inverter system, the function could be realized by: 1. Make sure Smart Meter connection and communication well. 2. Turn on Export Power Limit function and set the max output power to grid on APP. Note: If out-put power limit set as 0W,then there might still have deviation max 100W exporting to grid.

NO.	Problems	Solutions
19	Why there is still power exporting to grid after I set power limit as 0W?	Export limit could theoretically to minimum 0W, but there will have a deviation of around 100W for the hybrid inverter system.
20	Can I use other brand Meter to take over Smart Meter in the hybrid inverter system or change some settings on Smart Meter?	No, because the communication protocol is inset between inverter and Smart Meter, other brand Meter cannot communicate. Also any manual setting change could cause Meter communication failure.
21	What is the max current allowed going through CT on Smart Meter?	The max current for CT is 120A.
22	Is there a quick way to make the system work?	The shortest way, please refer to EHB QUICK INSTALLATION INSTRUCTIONS and SolarGo APP INSTRUCTION.
23	Whether the warranty of the inverter still valid if the installation or operation does not follow the user manual instructions, for some special conditions when we cannot 100% follow them?	Normally if any problem caused by disobeys the instructions on user manual, we can provide technical support to help to solve the problem, but cannot guarantee a replacement or returns. So if there is any special conditions when you cannot 100% follow the instructions, please contact the Service Center for suggestions.

If there's any problem cannot be solved by the above solutions, contact the Service Center for help.

Technical Data	GW5000-EHB	GW6500-EHB	GW8600-EHB	GW0010-EHB
Battery Input Data				
Battery Type	Li-Ion ^[2]			
Battery Voltage Range (V) ^[1]	80~495			
Max. Charging Current (A)	50			
Max. Discharging Current (A)	50			
Charging Strategy for Li-Ion Battery	Self-adaption to BMS			
PV String Input Data				
Max. DC Input Power (W)	7500	9750	12900	15000
Max. DC Input Voltage (V) ^[3]	600			
MPPT Range (V) ^[4]	80~550			
Start-up Voltage (V)	95			
MPPT Range for Full Load (V)	200~500	200~500	255~500	300~500
Nominal DC Input Voltage (V)	380			
Max. Input Current (A)	13/13/13	13/13/13/13		
Max. Short Current (A)	16.3/16.3/16.3	16.3/16.3/16.3/16.3		
No. of MPP Trackers	3	4		
No. of Strings per MPP Tracker	1/1/1	1/1/1/1		
AC Output Data (On-grid)				
Nominal Output Voltage (Vac)	230			
Nominal Output Frequency (Hz)	50			
Max. Apparent Power Output to Grid (VA) ^[5]	5000	6500	8600	10000
Max. Apparent Power from Grid (VA)	6000	7800	10000	10000
Max. AC Current Output to Grid (A)	23	28.5	39	43.5
Max. AC Current From Grid (A)	27	34	45.5	45.5
Output Power Factor	~1 (Adjustable from 0.8 leading to 0.8 lagging)			
Output THDi (@Nominal Output)	<3%			

Technical Data	GW5000-EHB	GW6500-EHB	GW8600-EHB	GW0010-EHB
AC Output Data (Back-up)				
Nominal Output Voltage (V) (Vac)	230 ($\pm 2\%$)			
Nominal Output Frequency (Hz)	50 ($\pm 0.2\%$)			
Automatic Switch Time (ms)	<10			
Output THDv (@Linear Load)	<3%			
Max. Continuous Output Apparent Power(VA)	5000	6500	8600	10000
Peak Output Apparent Power (VA) ^[6]	6000, 60sec	7800, 60sec	10320, 60sec	12000, 60sec
Max. Continuous Output Current (A)	23	28.5	39	43.5
Efficiency				
PV Max. Efficiency	97.6%			
PV CEC Efficiency	97.0%			
Battery Charged By PV Max. Efficiency	98.2%			
Battery Charge/discharge to AC Max. Efficiency	96.5%			
Protection				
PV Arc Fault Detection	Optional			
Rapid Shutdown System (RSS) Transmitter	Optional			
DC&AC Breaker, AC Bypass Switch	Integrated			
AC&DC SPD Type 2	Integrated			
Anti-islanding Protection	Integrated			
PV String Input Reverse Polarity Protection	Integrated			
Insulation Resistor Detection	Integrated			
Residual Current Monitoring Unit	Integrated			
Output Over Current Protection	Integrated			
Back-up Output Short Protection	Integrated			
Output Over Voltage Protection	Integrated			

Technical Data	GW5000-EHB	GW6500-EHB	GW8600-EHB	GW0010-EHB
Battery Input Reverse Polarity Protection	Integrated			
General Data				
Operating Temperature Range(°C)	-35~60			
Relative Humidity	0~95%			
Operating Altitude (m)	≤4000			
Cooling	Intelligent Fan			
Noise (dB)	<50			
User Interface	LED & APP(WiFi&Bluetooth)			
DC&AC Power Connect Port	MC4 & ADAPTER WIELAND			
Communication with BMS	RS485; CAN			
Communication with Meter	RS485			
Communication with EMS	RS485 (Insulated)			
Communication with Portal	Wi-Fi			
Communication with RSD	SUNSPEC			
Weight	28.8kg	32.3kg		
Size (Width*Height*Depth mm)	415 * 791 * 175			
Mounting	Wall Bracket			
Protection Degree	IP65			
Standby Self Consumption (W) ^[7]	<20			
Topology	Transformerless			
Certifications & Standards				
Grid Regulation	NRS 097-2-1:2017			
Safety Regulation	IEC62109-1&-2			
EMC	EN 61000-6-1, EN 61000-6-2, EN 61000-6-3, EN 61000-6-4, EN 61000-3-11, EN 61000-3-12, BS EN 50065-1:2011			
<p>[1]: Battery discharge/charge power limited by voltage. [2]: For more compatible battery options, please visit https://www.godwe.com for "Battery Options Statement". [3]: Inverter will not work when PV input voltage ≥585V. [4]: When there is no battery connected, inverter starts feeding in only if string voltage is higher than 200V. [5]: The grid feed in power for VDE-AR-N 4105 and NRS097-2-1 is limited to 4600VA. [6]: Can be reached only if PV and battery power is enough. [7]: No Back-up Output.</p>				

Other Tests

For Australian requirements, in the THDi test, Zref should be added between the inverter and mains.

RA, XA for the line conductor

RN, XN for the neutral conductor

Zref:

RA = 0, 24, XA = j0,15 at 50Hz

RN = 0, 16, XN = j0,10 at 50Hz

Protection category definition

Moisture location category definition

Moisture Parameters	Level		
	3K3	4K3	4K4H
Temperature Range	0~+40°C	-33~+40°C	~20~+55°C
Moisture Parameters	5%~85%	15%~100%	4%~100%

Environment category definition

Environment Condition	Ambient Temperature	Relative Humidity	Applied to
Outdoor	-20~50°C	4%~100%	PD3
Indoor Unconditioned	-20~50°C	5%~95%	PD3
Indoor conditioned	0~40°C	5%~85%	PD2

Overvoltage category definition

Category I	Applies to equipment connected to a circuit where measures have been taken to reduce transient overvoltage to a low level.
Category II	Applies to equipment not permanently connected to the installation. Examples are appliances, portables tools and other plug-connected equipment.
Category III	Applies to a fixed equipment downstream, including the main distribution board. Examples are switchgear and other equipment in an industrial installation.
Category IV	Applies to equipment permanently connected at the origin of an installation (upstream of the main distribution board). Examples are electricity meters, primary over-current protection equipment and other equipment connected directly to outdoor open lines.

Pollution degree definition

Pollution Degree I	No pollution or only dry, non-conductive pollution occurs. The pollution has no influence.
Pollution Degree II	Normally only non-conductive pollution occurs. Occasionally, however, a temporary conductivity caused by condensation must be expected.
Pollution Degree III	Conductive pollution occurs, or dry, non-conductive pollution occurs, which becomes conductive due to condensation, which is expected.
Pollution Degree IV	Persistent conductive pollution occurs, for example, the pollution caused by conductive dust, rain or snow.

GoodWe Technologies Co., Ltd.

 No. 90 Zijin Rd., New District, Suzhou, 215011, China

 www.goodwe.com

 service@goodwe.com



Local Contacts